



ANTEX Considerations for Multi-GNSS Work

O.Montenbruck, DLR/GSOC



Deutsches Zentrum
für Luft- und Raumfahrt e.V.
in der Helmholtz-Gemeinschaft

Slide 1

Antenna WG Meeting > IGS Workshop 2012 > Olsztyn > 2012/07/25



Naming Issues

- ANTEX provides cross-reference of variable and static spacecraft identifiers
 - „PRN“ (SP3 „vehicle ID“, RINEX „satellite number“, ANTEX „satellite code“)
 - „SVN“ (unique for each satellite)
- Need agreement on naming for most new spacecraft
 - Definition of GIOVE, Galileo, and COMPASS (and SBAS) SVNs
 - Harmonization of GIOVE-A/B PRN assignments (for postprocessing)
 - PRN handling for QZSS SAIF/non-SAIF
 - (PRN handling for COMPASS)



Antenna Reference Frame

- Current ANTEX convention based on nominal GPS Block IIA attitude law
 - Yaw steering law, -x to deep space, Sun in +x hemisphere
 - Other constellations „mapped“ to GPS-like axes
- Convenient, but simplistic?
 - Frame for patterns and offsets must be tied to satellite body, not the body's orientation in space
 - New satellites no longer follow the „standard“ attitude law
- Key problem cases
 - QZSS (yaw-steering alternates with orbit normal mode)
 - COMPASS GEOs (and IGSOs?)
 - SBAS
- Receiver antenna frame
 - Replace „East-North-Up“ by „X-Y-Z, where Z=boresight and Y=North Marker“



QZSS Body Frame and Attitude Modes

- Yaw-steering (YS) mode
 - Employed at high $|\beta|$ -angles
 - Similar to GPS but flipped x/y-axes (Sun in $-x$ -hemisphere, $+x$ into deep space)
- Orbit-normal (ON) mode
 - Employed at low $|\beta|$ -angles
 - Similar to geostationary satellites
 - $+y$ in anti-orbital momentum direction („south“ of orbital plane)
- Mode transition not fully predictable

Y. Ishijima, N. Inaba, A. Matsumoto, K. Terada, H. Yonechi, H. Ebisutani, S. Ukava, T. Okamoto, "Design and Development of the First Quasi-Zenith Satellite Attitude and Orbit Control System", Proceedings of the IEEE Aerospace Conference March 7-14 2009, Big Sky, MT, USA, (2009). DOI: 10.1109/AERO.2009.483953

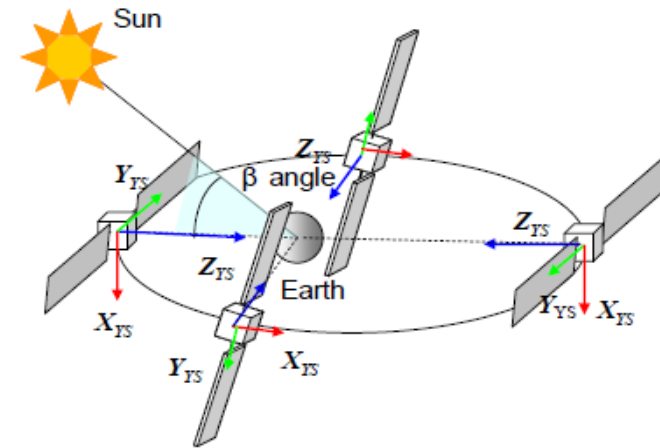

Yaw-steering Mode

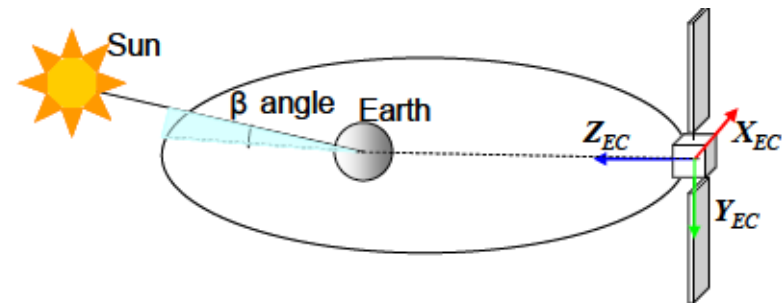

Orbit-normal („Earth-centered“) Mode



Spacecraft Body Frame and Attitude - Recommendations

- Promote decoupling of spacecraft body frame definition and spacecraft attitude law in IGS processing standards
 - Document manufacturer-defined spacecraft body frames
 - Use manufacturer-defined (=ILRS compatible) spacecraft body frames in ANTEX files for new constellations (GIOVE/Galileo, QZSS, COMPASS) but keep existing conventions for GPS and GLONASS
 - Establish standardized file format for GNSS attitude information (e.g. ORBEX) as an alternative to hardcoded-attitude laws
- Transition phase
 - Document mapping from manufacturer-defined spacecraft body frames to IGS standard model to assist GIOVE/Galileo and QZSS(YS) processing with legacy s/w
 - Introduce „ON-Y“ orbit-normal reference attitude model (with +y = „south“) as additional IGS standard for GEO and QZSS(ON) processing



QZSS SAIF Handling

- First GNSS satellite with two distinct transmit antennas
- Handling options
 - Different PRNs
 - Common PRN, different signal IDs, antennas distinguished by dedicated SAIF frequency band
 - Encode antenna number in 2nd digit of ANTEX frequency band indicator
 - ...
- Needs coordination with RINEX SAIF signal assignment

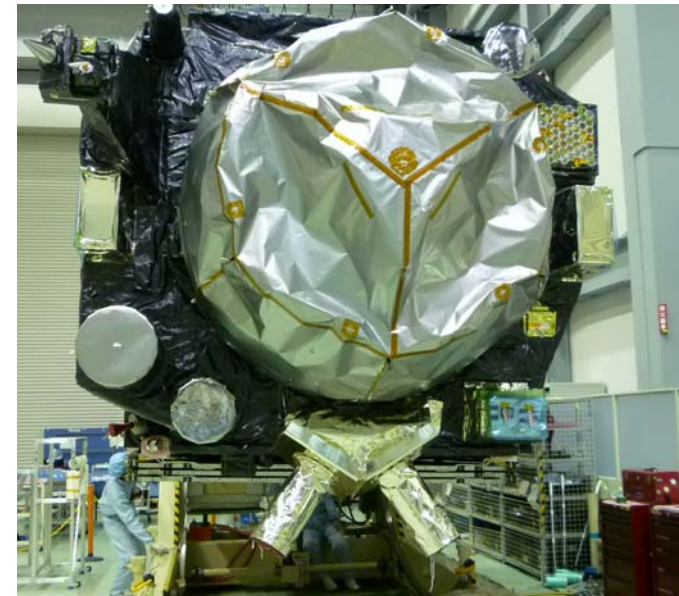



ANTEX Values

Recommendation

- Include all new constellations and frequencies into future ANTEX releases to enable consistent handling inside and outside the IGS
- Populate with
 - phase center offsets provided by operating agencies (GIOVE, QZS)
 - conventional values wherever agency information is not yet available (i.e., COMPASS, Galileo, SBAS, GPS L5)



DIRTY DETAILS





Topic 1

Satellite Identifiers



RINEX Satellite Identification

- „PRN“ of GNSS satellite identifies the transmitted ranging code as defined in the respective ICD
- RINEX employs 3-character „satellite number“
 - often termed „PRN“
 - NOT tied to a specific space vehicle
 - also used for SP3 orbit & clock files („vehicle ID“) and ANTEX („satellite code“)
- Assignment
 - <c> constellation letter (G,R,E,S,C,J)
 - <nn> two digit number (00..99), for example
 - GPS: G<nn>, nn = PRN
 - SBAS: S<nn>, nn = PRN -100
 - QZSS: J<nn>, nn = PRN - 192 (= PRN(SAIF) - 182)
 - GLONASS: R<nn>, nn defined by almanac slot
 - COMPASS: C<nn>, nn = PRN
- Only ANTEX provides cross reference of „satellite number“ and space vehicle



GIOVE-A/B PRNs (1)

- GIOVE ICDs^{[1][2]} define
 - dedicated ranging code sequences (unnumbered)
 - Space Vehicle Identifiers (1=GIOVE-A, 16=GIOVE-B)for the two precursor satellites of the „Galileo in Orbit Validation Element“
- SVID is transmitted in GIOVE broadcast navigation message
but
- ICD was released late (1½ years after GIOVE-A launch)
- Transmission of navigation msgs started late
- Early receivers developed under ESA contracts were based on possible GIOVE ranging codes covering the PRN range 51,...,99 (51=GIOVE-A, 52=GIOVE-B)

[1] GIOVE-A Navigation Signal-in-Space Interface Control Document; ESA-DEUI-NG-ICD/02703; Issue 1.0; 2 Mar 2007; Galileo Project Office, ESA, Noordwijk.

[2] GIOVE-A + B (#102) Navigation Signal-in-Space Interface Control Document; ESA-DTEN-NG-ICD/02837, Issue 1.1, 8 Aug 2008, Galileo Project Office, ESA, Noordwijk.



GIOVE-A/B PRNs (2)

- Current receivers use widely varying IDs for GIOVE-A/B

Receiver	GIOVE-A	GIOVE-B
Javad Triumph	1	2
Leica GRX1200+GNSS	1	16
Septentrio AsteRx3	32	31
Trimble NetR9	51	52
Septentrio GeNeRx1	51	52/53

- GIOVE signal structure and ranging codes are different from Galileo, but SVIDs will be reused



Galileo PRNs

- Galileo Open Service ICD^[3] defines
 - Shift register codes and 50 memory ranging code sequences
 - Assignment of ranging codes to SVIDs for 36 satellites (1..36)
- Recently launched Galileo IOV satellites employ SVIDs 11 and 12
- All known receivers consistently report Galileo IOV observations with PRN 11 (Galileo PFM*) and PRN 12 (Galileo IOV-2)

* Protoflight Model (or IOV-1)

[3] European GNSS (Galileo) Signal-in-Space Interface Control Document; OS SIS ICD, Issue 1, European Union, Feb. 2010.



PRN Assignment for GIOVE-A/B Satellites

- MGEX generates huge amount of observation data with inconsistent PRNs
 - Different receivers, data sources (offline/streaming), RINEX converters
- IGS needs to establish convention for GIOVE-A/B satellite identifiers
- Relevant options:
 - PRN 1/16:
 - Compatible with ESA usage and GIOVE-A/B navigation msg
 - Smallest overall range for GIOVE/Galileo PRN values (1..32)
 - PRN 51/52:
 - Clear distinction of GIOVE and Galileo satellite types
 - Avoids possible mixing of GIOVE and Galileo phase patterns in ANTEX
 - Compatible with draft RTCM3 MSM standard^[4]
 - Possibly incompatible with Bernese S/W
- **Recommendation**
 - **Define GIOVE-A/B PRNs for IGS use in RINEX Standard (RINEX WG)**

Unpublished
proposal of
RINEX WG

[4] Comments in Committee Draft for Vote Amendment 5 to RTCM Standard 10403.1 Differential GNSS Services - Version 3; Update to RTCM Paper 216-2011-SC104-680; 16 Feb 2012.



PRN Assignments for COMPASS/BeiDou-2

- Ranging codes of first COMPASS/BeiDou-2 satellite (M1) derived from high-gain antenna observations
- Other GEO and IGSO satellites use same code generator
 - Shift register settings identified by trial-and-error (Septentrio, Trimble)
 - „Private“ PRN numbering schemes
- Publication of „Test“ Signal ICD^[5] in Dec 2011
 - Definition of PRNs and ranging codes for 5 GEOs and 32 non-GEOs
 - First cross-identification of spacecraft in orbit and transmitted signals by Trimble and Septentrio
- **Recommendations (RINEX and GNSS WGs)**
 - **Document currently transmitted PRNs of all COMPASS satellites (see next page)**
 - **Ensure consistent application of „true“ PRNs in IGS(MGEX) work**

[5] BeiDou Navigation Satellite System Signal In Space Interface Control Document (Test Version), China Satellite Navigation Office December 2011.

<http://www.beidou.gov.cn/attach/2011/12/27/201112273f3be6124f7d4c7bac428a36cc1d1363.pdf>



COMPASS/BeiDou-2 Satellites and PRNs (May 2012)

Sat	PRN	COSPAR ID	NORAD ID	Type
G1	C01	2010-001A	36287	GEO
G2	C02	2009-018A	34779	GEO
G3	C03	2010-024A	36590	GEO
G4	C04	2010-057A	37210	GEO
G5	C05	2012-008A	38091	GEO
I1	C06	2010-036A	36828	IGSO
I2	C07	2010-068A	37256	IGSO
I3	C08	2011-013A	37384	IGSO
I4	C09	2011-038A	37763	IGSO
I5	C10	2011-073A	37948	IGSO
M1	C30	2007-011A	31115	MEO
M3	C11	2012-018A	38250	MEO
M4	C12	2012-018B	38251	MEO



Topic 2

Spacecraft Body-Frame and Attitude





GNSS Satellite Attitude

- Knowledge of GNSS satellite attitude required for
 - Modeling of transmit antenna offset from center-of-gravity (CoG)
 - Modeling of laser retroreflector offset from CoG
 - Modeling of phase wind-up effects
 - Modeling of solar radiation pressure

- Most common attitude:
 - Nadir-pointing transmit antenna
 - Solar panels oriented towards Sun
 - Requires continued „yaw-steering“

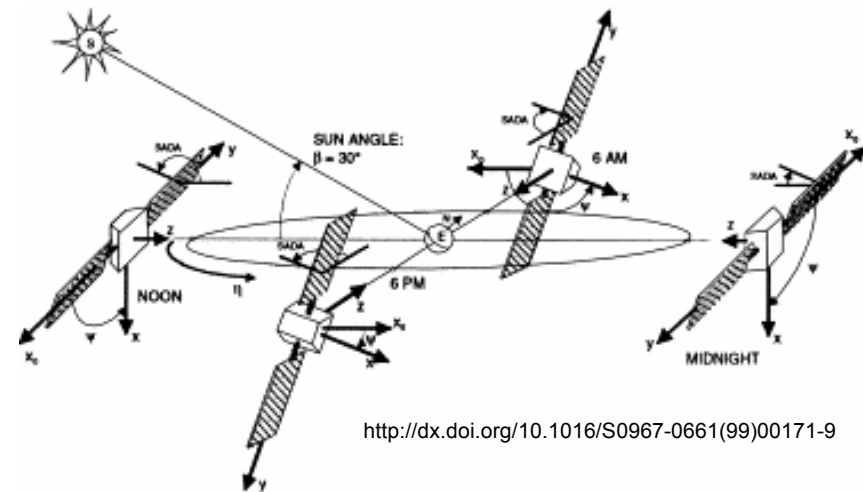

[http://dx.doi.org/10.1016/S0967-0661\(99\)00171-9](http://dx.doi.org/10.1016/S0967-0661(99)00171-9)



IGS Standard Model for GPS Body Frame and Attitude

- IGS employs an idealized model for the orientation of GNSS satellites (“IGS attitude model”) [6-8]
 - +z-axis Earth-pointing
 - +/-y-axis perpendicular to Earth- and Sun-direction
 - +x-axis completes right-hand system, Sun always in +x hemisphere, -x towards deep space
- The IGS attitude model
 - describes the nominal orientation of the spacecraft body axes of a GPS Block IIA satellite
 - has silently been identified with the spacecraft body axes of all other GPS and GLONASS satellites (that adhere to “similar” attitude laws) irrespective of actual manufacturer’s conventions

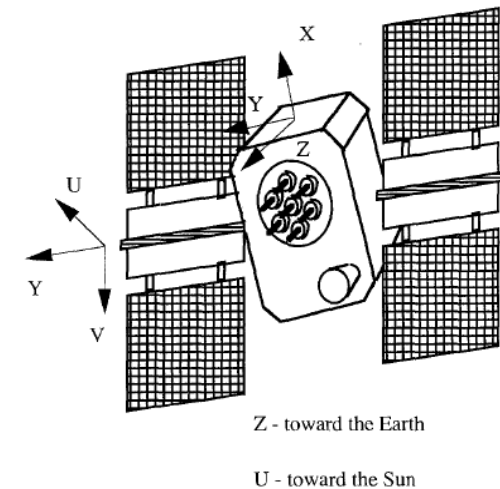

[6] D. Kuang, H. J. Rim, B. E. Schutz, P. A. M. Abusali, Modeling GPS satellite attitude variation for precise orbit determination; Journal of Geodesy 70(9):572-580. DOI: 10.1007/BF00867865

[7] Bar-Sever J.E., A new model for GPS yaw attitude, Journal of Geodesy 70(11):714-723 (1996). DOI: 10.1007/BF00867149

[8] Kouba J., A simplified yaw-attitude model for eclipsing GPS satellites, GPS Solutions 13:1–12 (2009). DOI 10.1007/s10291-008-0092-1



GLONASS-M/K1 Body Frame and Attitude Mode

- Spacecraft Coordinate System^[9,10]
 - +x-axis from center of Earth to spacecraft
 - +/-z-axis perpendicular to Earth- and Sun-direction
 - +y-axis completes right-hand system, Sun always in +y-hemisphere, -y towards deep space
- Commonly mapped to IGS standard model^[11]
 - $+x_{\text{GLO}} = -z_{\text{IGS}}$
 - $+y_{\text{GLO}} = +x_{\text{IGS}}$
 - $+z_{\text{GLO}} = -y_{\text{IGS}}$



[9] <http://ilrs.gsfc.nasa.gov/docs/GLONASSretroreflectorarraypositionrelativeCoM+99+102.pdf>

[10] http://ilrs.gsfc.nasa.gov/docs/glonass125_com.pdf

[11] F. Dilssner, T. Springer, G. Gienger, J. Dow; The GLONASS-M satellite yaw-attitude model Original Research Article; Advances in Space Research, 47(1):160-171 (2011).



GIOVE-A/B & Galileo IOV Body Frame and Attitude Control

- Yaw-steering mode
- Similar to GPS, but flipped axes (+x into deep space)^[12-15]

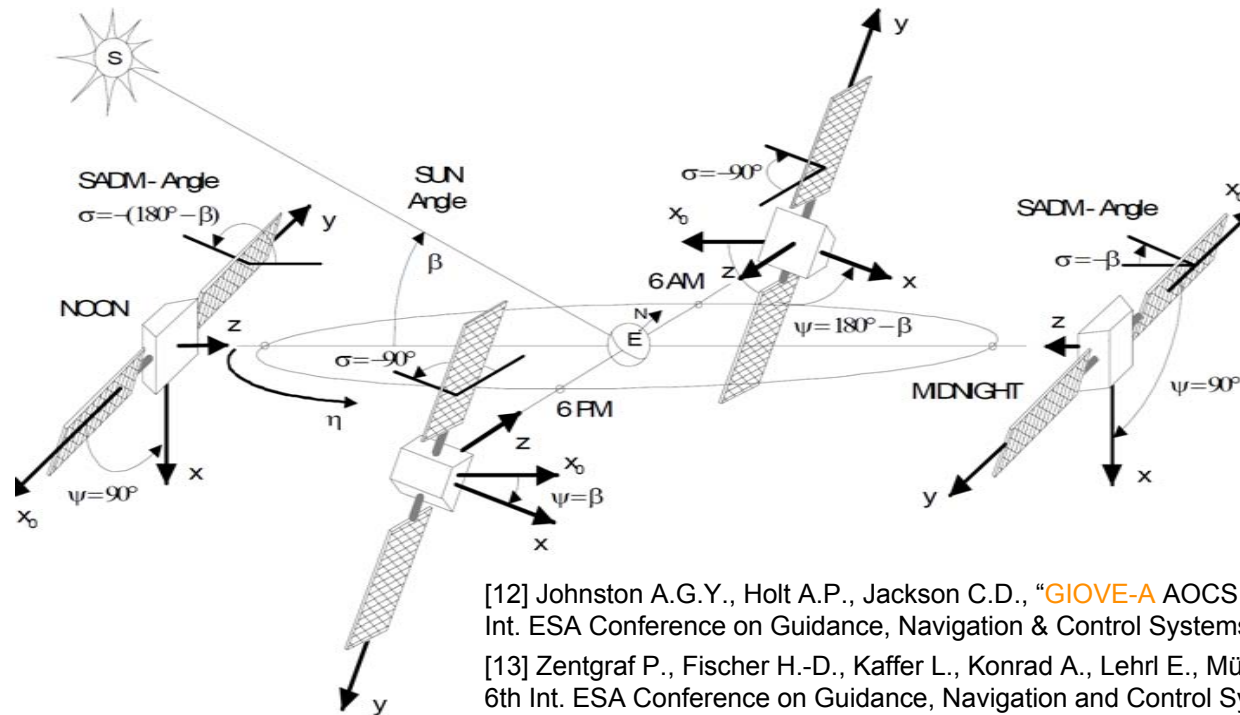

[12] Johnston A.G.Y., Holt A.P., Jackson C.D., "GIOVE-A AOCS : An Experience from Verification to Flight", 7th Int. ESA Conference on Guidance, Navigation & Control Systems, 2-5 June 2008, Tralee, County Kerry, Ireland

[13] Zentgraf P., Fischer H.-D., Kaffer L., Konrad A., Lehl E., Müller C., AOCS Design and Test for **GSTB-V2B**, 6th Int. ESA Conference on Guidance, Navigation and Control Systems, 17-20 Oct. 2005 in Loutraki, Greece.

[14] Konrad A., Fischer H.-D., Müller C., Oesterlin W.; Attitude & orbit control system for **Galileo IOV**; 17th IFAC Symposium on Automatic Control in Aerospace (2007). DOI 10.3182/20070625-5-FR-2916.00006

[15] R. Zandbergen, D. Nava, "Specifications of Galileo and GIOVE Space Segment properties relevant for Satellite Laser Ranging", ESA-EUING-TN/10206, Issue 3.2, 08/05/2008, Galileo Project Office, ESA, Noordwijk



QZSS Body Frame and Attitude Modes

- Yaw-steering (YS) mode^[16]
 - Employed at high $|\beta|$ -angles
 - Similar to GPS but flipped x/y-axes (Sun in $-x$ -hemisphere, $+x$ into deep space)

- Orbit-normal (ON) mode^[16]
 - Employed at low $|\beta|$ -angles
 - Similar to geostationary satellites
 - $+y$ in anti-orbital momentum direction („south“ of orbital plane)

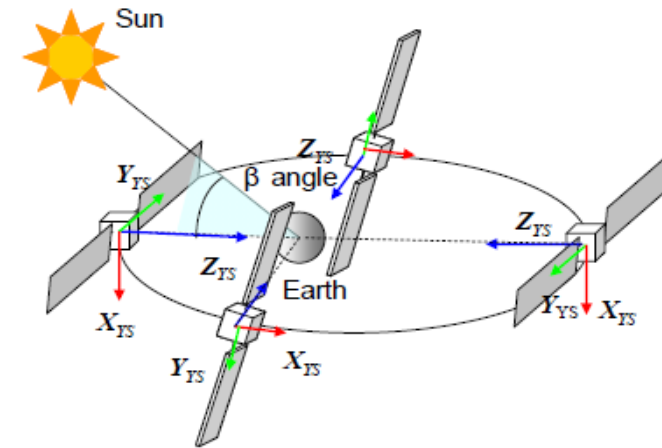

Yaw-steering Mode

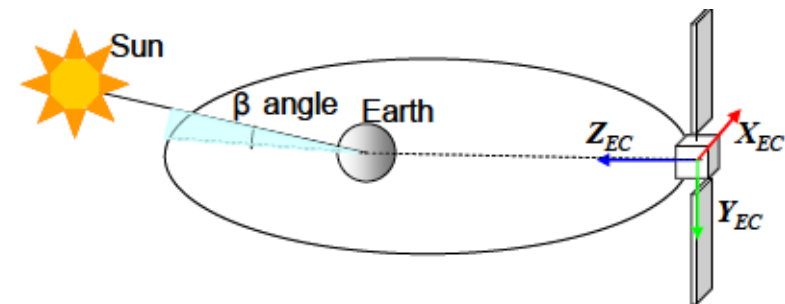

Orbit-normal („Earth-centered“) Mode

[16] Y. Ishijima, N. Inaba, A. Matsumoto, K. Terada, H. Yonechi, H. Ebisutani, S. Ukava, T. Okamoto, "Design and Development of the First Quasi-Zenith Satellite Attitude and Orbit Control System", Proceedings of the IEEE Aerospace Conference March 7-14 2009, Big Sky, MT, USA, (2009). DOI: 10.1109/AERO.2009.483953



COMPASS Body Frame and Attitude Modes

- No published information
- Presumed modes
 - Yaw steering mode for MEO satellites (possibly also for IGSOs)
 - Orbit normal mode for GEO satellites
- COMPASS-M1 SLR-only orbit determination
 - Good data fit (~ 1.5 cm) assuming yaw steering with Sun in +x-hemisphere
 - Bad fit (~ 5 cm) for yaw steering with Sun in -x-hemisphere

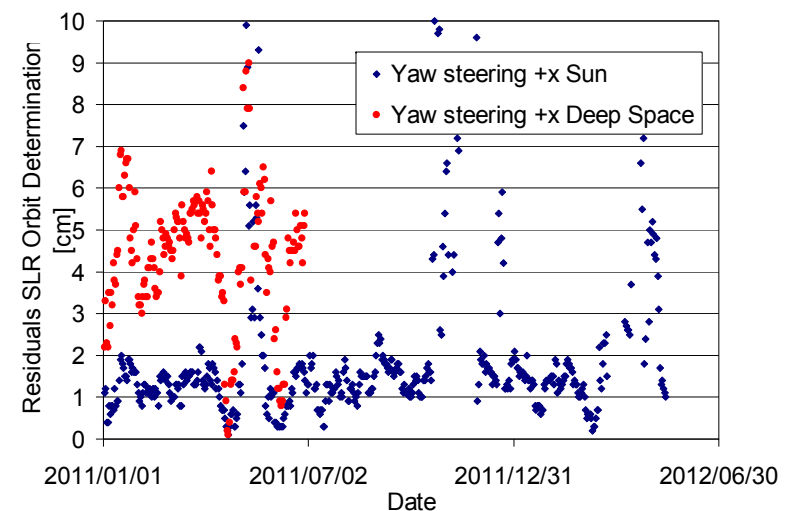



Summary of Body Frames and Attitude Modes

Constellation	Attitude Mode	Compatibility with IGS Attitude Model
GLONASS-M/K	yaw-steering	Requires mapping ($+x_{GLO} = -z_{IGS}$, $+y_{GLO} = +x_{IGS}$, $+z_{GLO} = -y_{IGS}$)
GIOVE-A/B	yaw-steering	Requires mapping ($+x_{GIO} = -x_{IGS}$)
Galileo IOV	yaw-steering	Requires mapping ($+x_{GAL} = -x_{IGS}$)
QZSS	yaw-steering	Requires mapping ($+x_{QZSS} = -x_{IGS}$)
	orbit-normal	NO
COMPASS MEO	yaw-steering	Yes*)
COMPASS IGSO	?	?
COMPASS GEO	orbit-normal (?)	NO
SBAS	orbit-normal (?)	NO

*) Inferred from satellite laser ranging measurements



Antenna and Sensor Offsets

- Antenna and sensor offsets must be provided in an *attitude-independent* spacecraft-body-fixed system
- ANTEX antenna offset information
 - „relative to the center of mass of the satellite in X-, Y- and Z-direction (in mm).”
 - Current data for all GPS/GLONASS sats refer to a s/c-body-fixed system that is parallel to the principal s/c axes but employs axes names and orientation matching the IGS attitude model
- ILRS uses coordinates in s/c body frame as provided in mission support request
- Inconsistency IGS↔ILRS

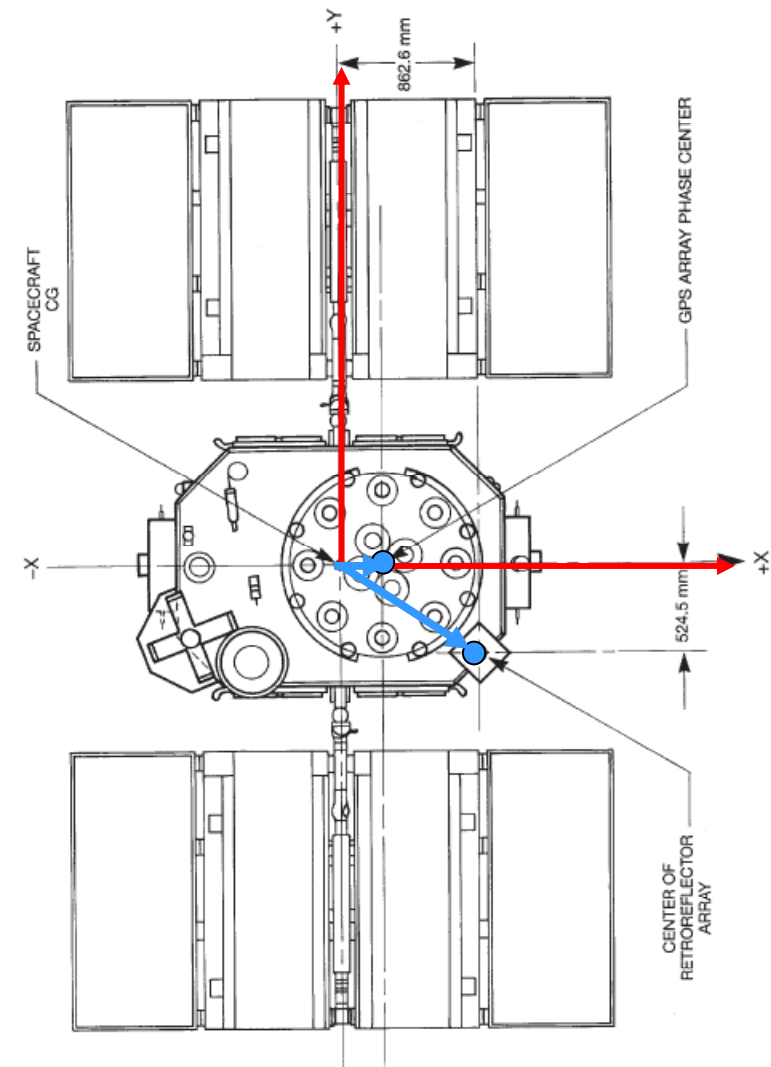

[17] Degnan JJ, Pavlis EC (1994) Laser ranging to GPS satellites with centimeter accuracy. GPS World, September 1994, pp 62-70



Spacecraft Body Frame and Attitude - Discussion

- Current practice of IGS standard yaw steering law is „convenient“ but apparently outdated
 - Mapping of satellite body frame for alternate yaw-steering laws causes inconsistencies with other agencies and is a persistent source of confusion concerning the actual sensor coordinates
 - Standard yaw-steering law is a major obstacle for processing new GNSS systems (QZSS, COMPASS-GEO, SBAS)
 - Standard yaw steering law often breaks down at noon/midnight turns
- Constellation-specific standard attitude laws
 - Might provide preliminary workaround
 - Need at least three basic modes (YS+X, YS-X, ON-Y) and rules for mode transitions
 - Cannot capture true instant of mode transitions (QZSS(YS)↔QZSS(ON))
- COMPASS attitude conventions still largely unknown



Spacecraft Body Frame and Attitude - Recommendations

Recommendations (IGS)

- Promote decoupling of spacecraft body frame definition and spacecraft attitude law in IGS processing standards
 - Document manufacturer-defined spacecraft body frames
 - Use manufacturer-defined (=ILRS compatible) spacecraft body frames in ANTEX files for new constellations (GIOVE/Galileo, QZSS, ...) but keep existing conventions for GPS and GLONASS
 - Establish standardized file format for GNSS attitude information (e.g. ORBEX) as an alternative to hardcoded-attitude laws
- Transition phase
 - Document mapping from manufacturer-defined spacecraft body frames to IGS standard model to assist GIOVE/Galileo and QZSS(YS) processing with legacy s/w
 - Introduce „ON-Y“ orbit-normal reference attitude model (with +y = „south“) as additional IGS standard for GEO and QZSS(ON) processing



Topic 3

Antenna Information



GPS L5 Satellite Antenna Offsets

- Current IGS ANTEX files provide only GPS L1/L2 PCOs and PCVs
- For build-up of multi-frequency processing capabilities, IGS ANTEX files should be extended to include L5 PCOs and PCVs
- Affects (currently) G01 and G25
- Problems
 - Insufficient observation data (sparse network) and lacking analyses for L5 PCOs/PCVs
 - Current L1 and L2 PCOs/PCVs represent ionosphere-free L1/L2 PCOs/PCVs
- **Recommendations (Antenna WG)**
 - Add „G05“ frequency section for PRN G01 and G25
 - Fill with copy of L1/L2 PCOs/PCVs until refined values can be derived from observations
 - Interpret values as ionosphere-free L1/L5 PCOs/PCVs until alternative definitions can be made



QZSS SAIF Handling (1)

- QZSS transmits^[18]
 - L1 C/A, L1C, L2C, L5, L6 LEX through primary antenna (L-ANT)
 - L1 SAIF through secondary antenna (LS-ANT)
- Different PRNs for SAIF (183..) and other signals (193...)
- Currently no RINEX signal code for SAIF, no antenna offsets in ANTEX
 - BINEX/RINEX signal assignment initially deprecated by JAXA
- Preliminary BINEX signal ID (=30) assigned recently^[19]

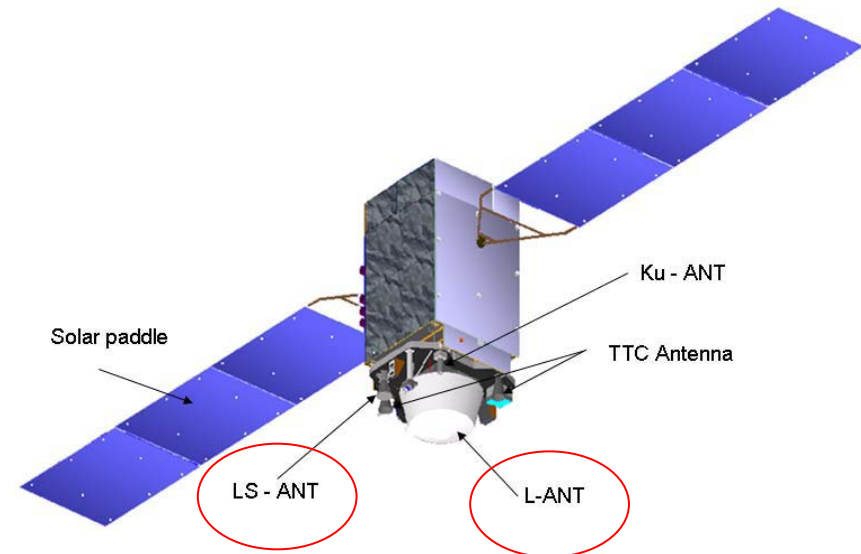

[18] Quasi-Zenith Satellite System Navigation Service - Interface Specification for QZSS; IS-QZSS, Draft Issue v1.2, 10 Mar 2010.

[19] http://binex.unavco.org/binex_record_7f.html#7f_05



QZSS SAIF Handling (2)

Questions

- How to store and use SAIF observations?
- How to deal with two PRNs for one s/c?
- How to deal with two antennas for a single s/c?

- Options
 - #0: distinct RINEX satellite identifiers (e.g. J01 but S83 for SAIF)
 - Highly deprecated: causes duplication of orbit/clock information, inhibits joint processing
 - #1: supplementary RINEX frequency band number for SAIF
 - #2: reinterpretation of ANTEX frequency indicator as antenna/frequency indicator



QZSS SAIF Handling – Option 1

- Introduce dedicated RINEX band/frequency indicator <n> for SAIF
 - Candidates: „0“ or „9“ (both are currently unused in all constellations)
- Assign attribute <a> for SAIF
 - Candidates: „S“ (for SAIF; possible confusion with „short“ component of L1C), „Z“ (private use by DLR/CONGO; currently unused for GPS/QZS L1 signals)
- Discussion
 - Drawbacks:
 - first use of two distinct numbers for the very same frequency
 - Benefits:
 - fully compatible with current ANTEX conventions
 - allows distinct antenna offsets despite identical frequency
 - antenna coordinates can be obtained from ANTEX file based on RINEX obs type without further side knowledge



QZSS SAIF Handling – Option 2

- Keep common RINEX band/frequency indicator „1“ for all QZSS L1 signals, i.e. L1 C/A, L1 and SAIF
- Assign signal attribute <a> (e.g. „Z“) for SAIF
- Re-interpret obsolete second digit of ANTEX „frequency number code“ as antenna number
 - Current definition: <c><nn> with
 - <c>=constellation letter („G“, „R“, „E“, ...)
 - <nn> = RINEX frequency band, padded with leading „0“ („01“, „02“, „05“, „07“, or „08“)
 - New: <c><a><n> with
 - <c>=constellation letter („G“, „R“, „E“, ...)
 - <a>=antenna number („0“, except for QZSS SAIF antenna)
 - <n> = RINEX frequency band, i.e., „1“, „2“, „5“, „7“, or „8“
- Discussion
 - Keep unique RINEX band/frequency indicator for a given frequency
 - Need to know which signal comes from which antenna when processing ANTEX



QZSS SAIF Handling – Recommendations

Recommendations

- Discuss feasibility of distinct RINEX band/frequency indicator for QZSS L1 SAIF signal (RINEX WG)
- Assign signal code for QZSS L1 SAIF signal (RINEX WG)
- Discuss feasibility of optional antenna indicator (Antenna WG)
- Decide on consolidated strategy for SAIF handling (Antenna and RINEX WGs)



ANTEX Data for New Constellations and Satellites

- Current ANTEX file provides only GPS & GLONASS
- Multi-constellation processing requires PCO/PCV data for Galileo, COMPASS, QZSS, and SBAS
- Sparse tracking networks and limited processing tools
 - PCV estimation not yet feasible (mostly)
 - Limited impact of „erroneous“ PCOs on orbit quality
- Inconsistent PCO assumptions result in inconsistent clock products

Recommendations (Antenna WG)

- Define satellite block names („antenna types“) in `rcvr_ant.tab`
- Adopt conventional PCOs (with zero PCVs) for all satellites in orbit to ensure consistency of multi-GNSS data products (see next slides)
- Encourage estimation of PCO/PCV values and update ANTEX as soon as more reliable information becomes available



GIOVE/Galileo Antenna Information

- Antenna offsets for GIOVE-A/B published by Galileo Project Office along with SLR support information^[15]
- Informal proposal^[20] on ANTEX conventions for GIOVE/Galileo prepared by ESA and provided to Antenna WG in 2010
- Only limited/preliminary phase pattern information available so far from ground calibration^[21] or GESS monitoring network^[22]

[15] R. Zandbergen, D. Nava, “Specifications of Galileo and GIOVE Space Segment properties relevant for Satellite Laser Ranging”, ESA-EUING-TN/10206, Issue 3.2, 08/05/2008, Galileo Project Office, ESA, Noordwijk

[20] Galileo information for IGS-ANTEX; System Team, ESA 30 July 2010

[21] P. Valle, A. Netti, M. Zolesi, R. Mizzoni, M. Bandinelli, R. Guidi. “Efficient dual-band planar array suitable to GALILEO”, EUCAP-2006, 6-10 November 2006 Nice France.

[22] Gonzalez F., Binda S; GIOVE—Mission and experimentation update, IGS WS 2010, Newcastle



GIOVE/Galileo Spacecraft Types

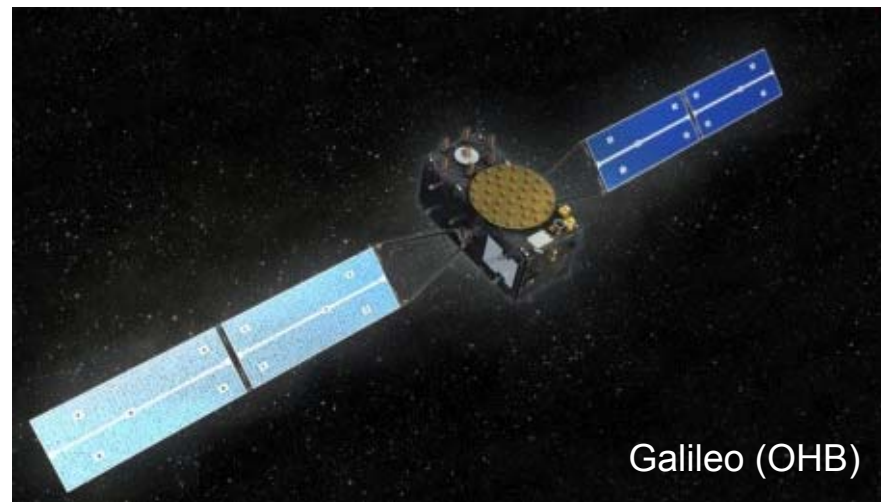
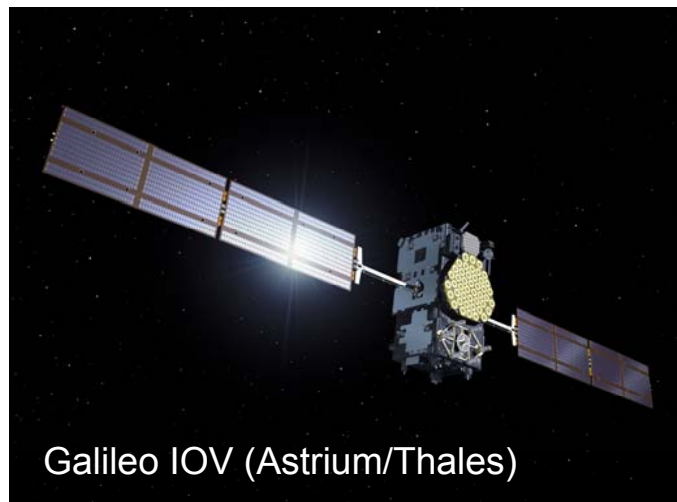



GIOVE/Galileo Antenna Types and Satellite Codes

ESA Proposal^[20]

Antenna Type	Description	Optional Satellite Code (SVN)
GALILEO-0A ^{*)}	GIOVE-A	E001
GALILEO-0B ^{*)}	GIOVE-B	E002
GALILEO-1 ^{*)}	Galileo IOV Satellites	E101-E104
GALILEO-2	Galileo	E201-E222
GALILEO-3

^{*)} Already included in rcvr_ant.tab

Recommendation (Antenna WG)

- Accept and implement proposal for Galileo-2 antenna code and GSAT numbers up to GALILEO-2 / GSAT 222 in rcvr_ant.tab and igs08.atx



GIOVE/Galileo Satellites

➤ TYPE / SERIAL NO records for current constellation

Antenna Type	Satellite Code (PRN)	Satellite Code (SVN)	COSPAR ID
GALILEO-0A	E01 / E51	E001	2005-051A
GALILEO-0B	E16 / E52	E002	2008-020A
GALILEO-1	E11	E101	2011-060A
GALILEO-1	E12	E102	2011-060B
...

Recommendation (Antenna WG)

➤ Incorporate current GIOVE/Galileo satellites into igs08.atx



GIOVE-A/B Antenna Offsets (1)

GIOVE-A Parameters^[10]

Phase center coordinates

E5a + E5b	E6	E2/L1/E2
X = 0.0 mm	X = 0.0 mm	X = 0.0 mm
Y = 0.0 mm	Y = 0.0 mm	Y = 0.0 mm
Z = 1690.0 mm	Z = 1665.0 mm	Z = 1658.0 mm

Center of gravity (Mar 2006)

X = -4 mm
 Y = 1 mm
 Z = 796 mm

GIOVE-B Parameters^[10]

Phase center coordinates

E5a + E5b	E6	E2/L1/E2
X = 0.0 mm	X = 0.0 mm	X = 0.0 mm
Y = 0.0 mm	Y = 0.0 mm	Y = 0.0 mm
Z = 2288.7 mm	Z = 2287.6 mm	Z = 2289.15 mm

Center of gravity (BOL)

X = -3.2 mm
 Y = 3.4 mm
 Z = 937.5 mm

SLR coordinates

X = -807.5 mm
 Y = 297.5 mm
 Z = 2267.6 mm

[15] R. Zandbergen, D. Nava, "Specifications of Galileo and GIOVE Space Segment properties relevant for Satellite Laser Ranging", ESA-EUING-TN/10206, Issue 3.2, 08/05/2008, Galileo Project Office, ESA, Noordwijk



GIOVE-A/B Antenna Offsets (2)

Derived antenna coordinates relative to CoG and GIOVE s/c axes
(manufacturer system)

Spacecraft	Frequency	X [mm]	Y [mm]	Z [mm]
GIOVE-A	E1	+4	-1	+862
	E5a+b	+4	-1	+894
	E6	+4	-1	+869
GIOVE-B	E1	+3.2	-3.4	+1351.6
	E5a+b	+3.2	-3.4	+1351.2
	E6	+3.2	-3.4	+1350.1



Options for GIOVE Data in IGS ANTEX File

Reference frame

- Option 1: Manufacturer frame
 - Future minded, compatible with ILRS
 - Needs „manual“ mapping for use in legacy IGS processing s/w
- Option 2: IGS attitude model
 - Compatibility with existing tools

Offset values

- Option A: Use frequency-wise PCOs as documented by ESA
 - Compatible with existing processing by various centers and agencies
 - Processing s/w must support frequency-wise PCO values
- Option B: Use derived ionosphere-free PCOs
 - Less transparent
 - Compatible with PCO/PCV estimation from observations



Proposed GIOVE Antenna Offsets for IGS ANTEX File

Option1 A

- All values in manufacturer system
- Frequency specific values, E5a and E5b equated to E5ab

Note: Ref [20] erroneously proposes offsets w.r.t. origin of s/c ref frame, not CoG

Antenna	Band	X [mm]	Y [mm]	Z [mm]
GALILEO-0A	E01	+4.0	-1.0	+862.0
	E05	+4.0	-1.0	+894.0
	E07	+4.0	-1.0	+894.0
	E08	+4.0	-1.0	+894.0
	E06	+4.0	-1.0	+869.0
GALILEO-0B	E01	+3.2	-3.4	+1351.6
	E05	+3.2	-3.4	+1351.2
	E07	+3.2	-3.4	+1351.2
	E08	+3.2	-3.4	+1351.2
	E06	+3.2	-3.4	+1350.1



GIOVE-A/B Antenna Offsets (2)

Recommendations (Antenna WG)

- Provide antenna offsets of GIOVE-A/B in future igs08.atx release
- Provide individual values for 5 frequency bands (E01, E05, E07, E08, E06) instead of ionosphere-free combinations
- Set phase patterns to zero
- Adopt GIOVE-A/B antenna offsets for E1, E5a+b, E6 from [15]
- Set E5a and E5b offsets equal to E5a+b offsets
- Add note on employed spacecraft body reference system (GIOVE-specific, +x to deep-space), even though x/y-offset is essentially negligible



Galileo IOV

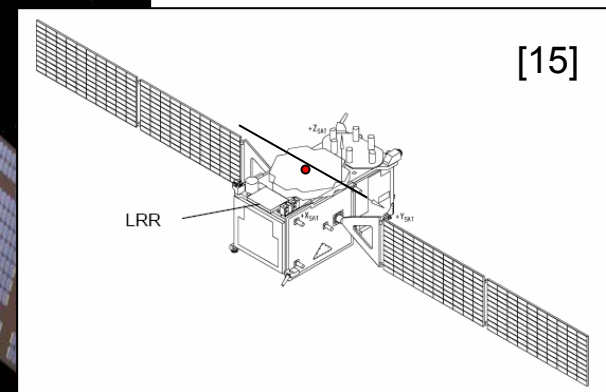
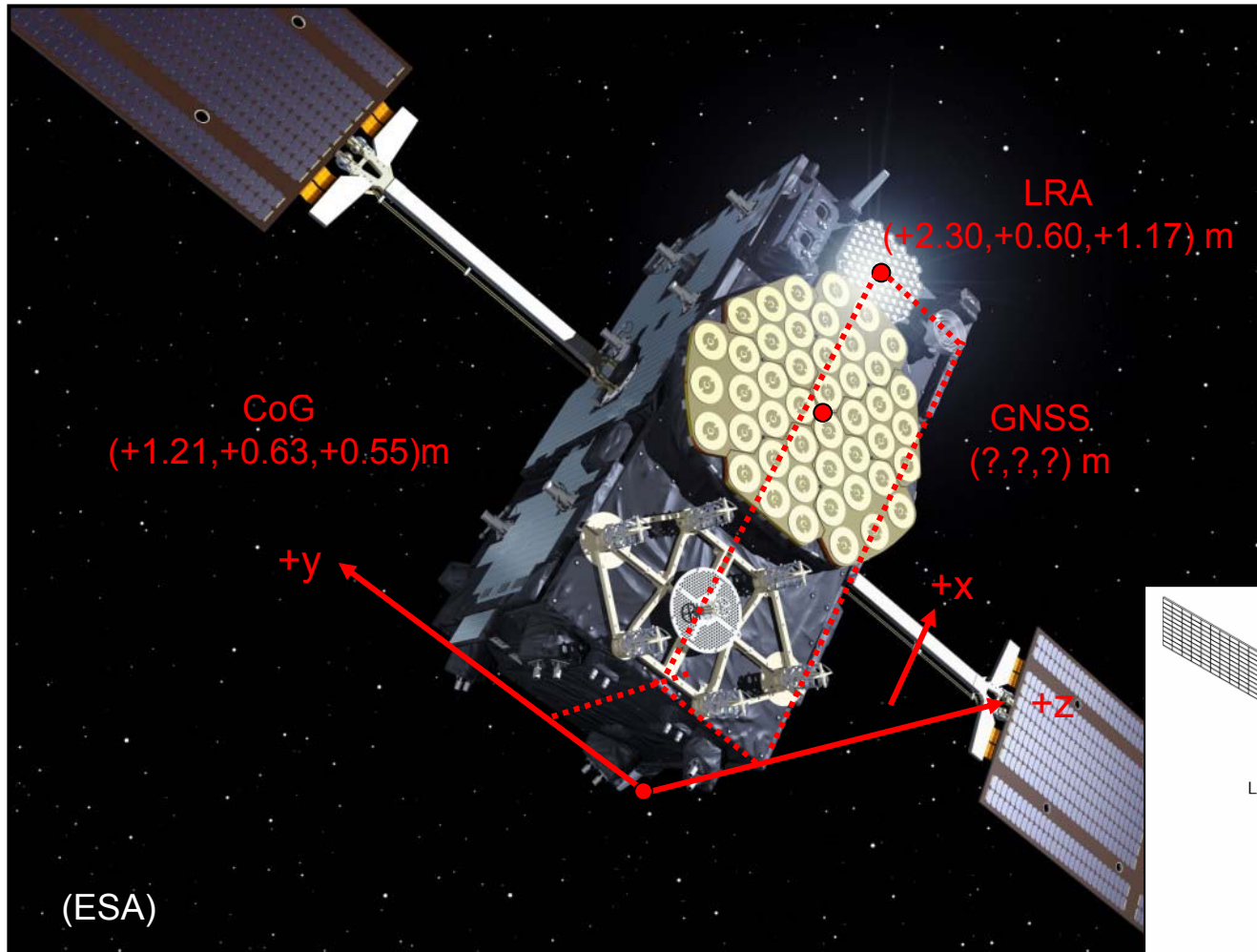



Galileo IOV GNSS Antenna Position

- Drawings/images suggest symmetric placement wrt s/c body in y-direction
- Drawings/images suggest small +x offset relative to s/c body center
- Assume similar z-coordinate of SLR and GNSS phase centers (GIOVE-B SLR and GNSS phase centers differ by less than 3 cm)
- LRA and CoG coordinates given in ILRS mission support request^[23]
 $x = 2.298 \text{ m}, y = 0.595 \text{ m}, z = 1.174 \text{ m}$ CoM will be around $X=1.21 \text{ m}, Y=0.63 \text{ m}, Z=0.55 \text{ m}$
- Best-guess PCO coordinates relative to CoG (Galileo s/c axes)

Spacecraft	X [m]	Y [m]	Z [m]
Galileo IOV	+0.2 ± 0.1	+0.0 ± 0.1	+0.6 ± 0.1

- Presently, ESA does not plan to provide official values before concise inflight calibration of antennas of IOV and first FOC satellites

[23] http://ilrs.gsfc.nasa.gov/docs/ILRS_MSR_Galileo_201106.pdf



Proposed Galileo IOV Antenna Offsets for IGS ANTEX

PRN	SVN	Antenna Type	Band	X [mm]	Y [mm]	Z [mm]
E11	E101	GALILEO-1	E01	+200.0	+0.0	+600.0
			E05	+200.0	+0.0	+600.0
			E07	+200.0	+0.0	+600.0
			E08	+200.0	+0.0	+600.0
			E06	+200.0	+0.0	+600.0
E12	E102	GALILEO-1	E01	+200.0	+0.0	+600.0
			E05	+200.0	+0.0	+600.0
			E07	+200.0	+0.0	+600.0
			E08	+200.0	+0.0	+600.0
			E06	+200.0	+0.0	+600.0

➤ All values in manufacturer system



Galileo IOV Antenna Offsets

Recommendations (Antenna WG)

- Provide preliminary antenna offsets of Galileo IOV in future igs08.atx releases
- Provide common values for each band (E01, E05, E07, E08, E06)
- Set phase patterns to zero
- Employ manufacturer-specific frame
- Adopt best-guess values (+0.2m,+0.0m,+0.6m)
- Add note on employed spacecraft body reference system (Galileo, +x to deep-space) since x-offset is non-negligible
- Promote rapid inflight calibration of antenna offsets (and PCVs?) from publicly available observations



QZSS

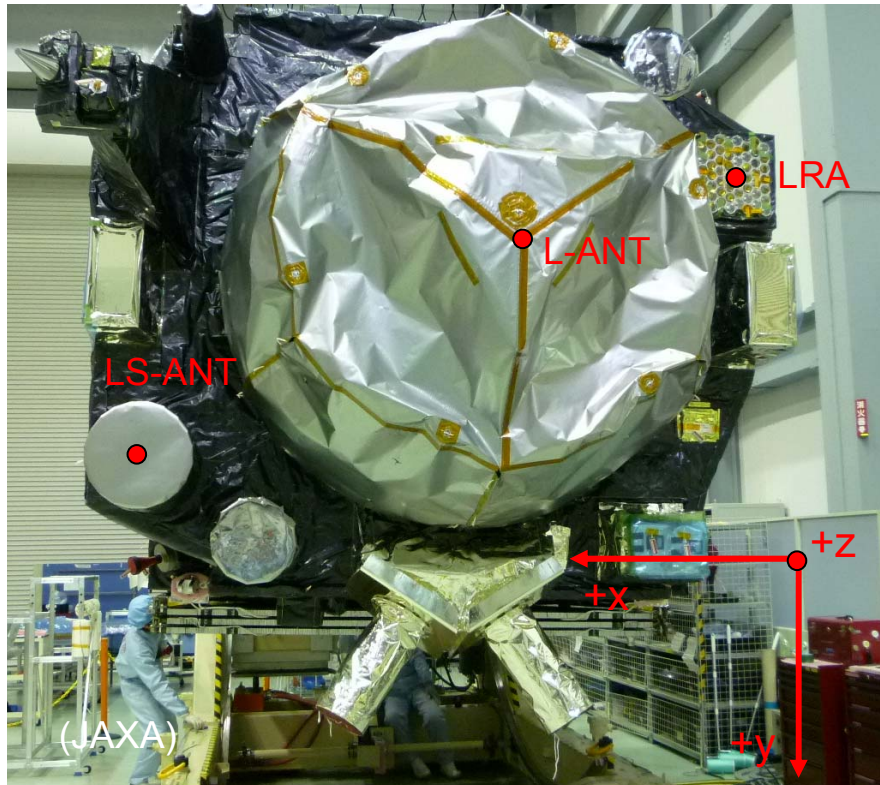

QZSS Parameters

	X [mm]	Y [mm]	Z [mm]
LRA ^[24]	-1150.0	-550.0	4505.3
CoG(BOL) ^{[25]*}	-0.9	2.9	1819.2
CoG(MOL) ^{[25]*}	-0.9	3.0	1835.2
CoG(EOL) ^{[25]*}	-0.9	3.1	1851.2
CoG(2012/07) ^{[25]*}	-0.9	2.9	1819.9
L-ANT (L1) ^[25]	0.0	0.0	5017.84
LS-ANT ^[25]	1150.0	700.0	4835.04

* Estimated figure based on the measurement results at launch site just before launch

[24] http://ilrs.gsfc.nasa.gov/docs/ILRS_retroreflector_QZS_20100729.pdf

[25] eMail S.Kogure to O.Montenbruck of 20 July 2012

LRA = Laser Retroreflector Assembly

COG = Center-of-Gravity

L-ANT = L-Band Antenna

LS-ANT = L-Band SAIF Antenna

BOL = Begin-of-Life

MOL = Middle-of-Life

EOL = End-of-Life



Proposed QZSS Antenna Offsets for IGS ANTEX

PRN	SVN	Antenna Type	Band	X [mm]	Y [mm]	Z [mm]
J01	J001	QZSS ^{*)}	J01	0.9	-2.9	3197.9
			J02	0.9	-2.9	2992.9
			J05	0.9	-2.9	3077.9
			J06	0.9	-2.9	3147.9
			J09 ^{**)}	1150.9	697.1	3015.1

^{*)} Already defined in rcvr_ant.tab

^{**)} Note: J09 used as example for possible SAIF antenna „frequency“ band indicator

- All values rounded to 0.1 mm
- CoG moves by 30 mm (in z-direction) over the mission life-time; above values based on present CoG of (-0.9,+2.9,+1819.9) mm
- All values refer to QZSS coordinate system (which has +x to deep-space in yaw steering mode)



QZSS Antenna Offsets

Recommendations (Antenna WG)

- Provide antenna offsets of QZSS in future igs08.atx releases
- Provide specific JAXA values for each band (J01, J02, J05, J06)
- Adopt „QZSS-1“ spacecraft („antenna“) code
- Adopt JAXA L1 values for L-ANT
- Provide distinct entry for SAIF antenna
- Set all phase patterns to zero
- Adopt QZSS manufacturer-specific coordinate system
- Add note on employed spacecraft body reference system (QZSS-specific, +x to deep-space in yaw-steering, +x along-track in orbit-normal mode at $|\beta| < 20$)



COMPASS/BeiDou-2

- Almost no spacecraft information available
- All satellites of BeiDou-2 system use the same basic spacecraft bus but differ in their payload^[26]
 - DFH-3 for MEO/IGSO^[27]
 - DFH-3A for GEO^[27]
- GEOs equipped with C-band dish antenna, drawings show different GNSS L-band antenna layout w.r.t. MEO/IGSO
- CoG and LRA coordinates provided in ILRS mission support requests^[28]

[26] Han C, Yang Y, Cai Z (2011) BeiDou Navigation Satellite System and its timescales, Metrologia 48:S213-S218. DOI: 10.1088/0026-1394/48/4/S13

[27] Xie Jun, Wang Jingang und Mi Hong; Analysis of Beidou Navigation Satellites In-orbit State; China Satellite Navigation Conference (CSNC) 2012 Proceedings; Lecture Notes in Electrical Engineering, 2012, Volume 161, Part 1, 111-122, DOI: 10.1007/978-3-642-29193-7_10

[28] http://ilrs.gsfc.nasa.gov/satellite_missions/list_of_satellites/com1_com.html



COMPASS/BeiDou-2 Satellites

BeiDou-2 GEO (DFH-3A)

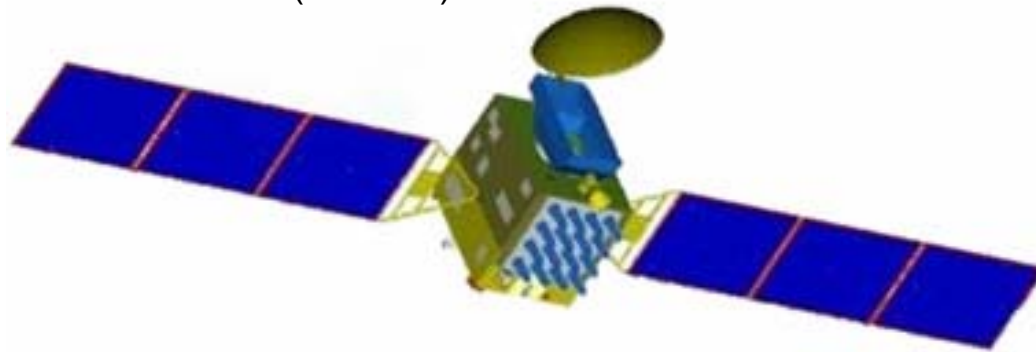

DFH-3 Bus

BeiDou-2 MEO/IGSO (DFH-3)

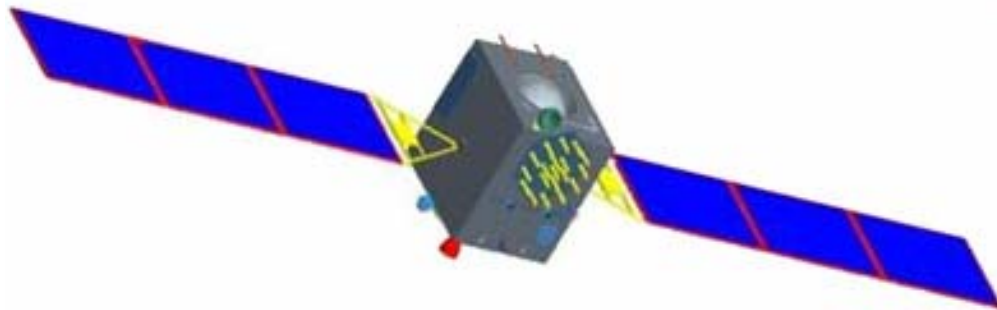

Images: http://space.skyrocket.de/doc_sdat/bd-2m.htm



COMPASS/BeiDou-2 Spacecraft Body Frame

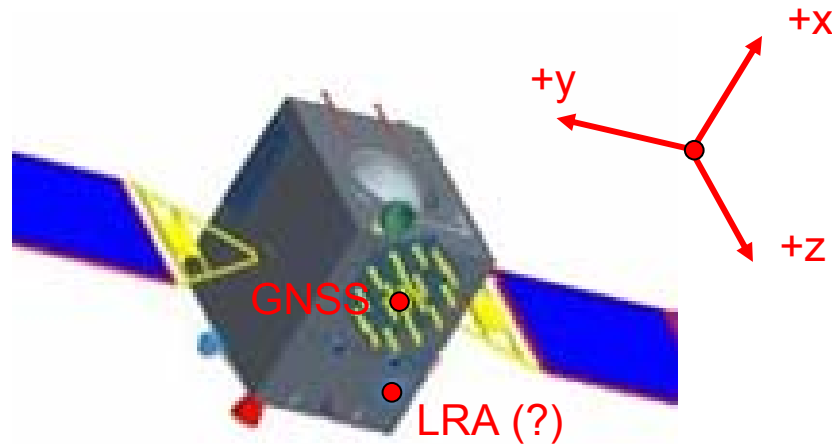

MEO/IGSO body frame as inferred from CoG and LRA coordinates

COMPASS Center of Mass				
	COMPASS-M1	COMPASS-M3	COMPASS-G1	COMPASS-I3
Satellite CoM relative to satellite-based origin:	(1082.0, -0.4, -0.5) mm	(1082.0,-0.4,-0.5)mm	(1152.5,0.2,0.0)mm	(1075.6,0.0,-0.4)mm
Location of phase center of the LRA relative to a satellite-based origin:	(649.9, -562.5, 1112.3) mm	(649.9,-562.5,1112.3)mm	(608.8,-570.2,1093)mm	(673,573,1093)mm
Position and orientation of the LRA reference point relative to a satellite-based origin:	(649.9,-562.5, 1133.3) mm	(649.9,-562.5,1133.3)mm	(608.8,-570.2,1114)mm	(673,573,1114)mm

http://ilrs.gsfc.nasa.gov/satellite_missions/list_of_satellites/com1_com.html



Proposed COMPASS/BeiDou-2 Antenna Types and Satellite Codes

Antenna Type	Satellite Code (PRN)	Satellite Code (SVN)	COSPAR ID
BEIDOU-2G	C01	C003	2010-001A
BEIDOU-2G	C02	C002	2009-018A
BEIDOU-2G	C03	C004	2010-024A
BEIDOU-2G	C04	C006	2010-057A
BEIDOU-2G	C05	C011	2012-008A
BEIDOU-2I	C06	C005	2010-036A
BEIDOU-2I	C07	C007	2010-068A
BEIDOU-2I	C08	C008	2011-013A
BEIDOU-2I	C09	C009	2011-038A
BEIDOU-2I	C10	C010	2011-073A
BEIDOU-2M	C11	C012	2012-018A
BEIDOU-2M	C12	C013	2012-018B
BEIDOU-2M	C30	C001	2007-011A



COMPASS/BeiDou-2 GNSS Antenna Position

- Drawings/images suggest symmetric placement wrt s/c body in y-direction
- Drawings/images suggest +x offset relative to s/c body center
- Assume similar z-coordinate of SLR and GNSS phase centers
- LRA and CoG coordinates given in ILRS mission support request^[28]
 - z-offset approximately +1.1 m (for MEO/IGSO/GEO)
- Best-guess PCO coordinates relative to CoG (COMPASS s/c axes)

Spacecraft	X [m]	Y [m]	Z [m]
BEIDOU-2G	+0.8 ± 0.4	+0.0 ± 0.1	+1.1 ± 0.1
BEIDOU-2I/M	+0.5 ± 0.2	+0.0 ± 0.1	+1.1 ± 0.1

- Presently no official/public PCO information available

[28] http://ilrs.gsfc.nasa.gov/satellite_missions/list_of_satellites/com1_com.html



COMPASS/BeiDou-2 Antenna Offsets

Recommendations (Antenna WG)

- Add new „antenna“ code BEIDOU-2G, BEIDOU-2M, BEIDOU-2I to rcvr_ant.tab
- Provide antenna offsets of COMPASS/BeiDou-2 in future igs08.atx releases
- Provide common values for each band (C02, C06, C07)
- Set all phase patterns to zero
- Add note on presumed spacecraft body orientation
 - GPS-like yaw steering with $-x$ to deep space for MEOs and IGSOs
 - Orbit-normal mode $+x$ along-track for GEOs